

B

C

E

公差表

REV	ECN NO	LOCATIONS	DESCRIPTION	DATE	CHANGER
A			新版本	2016-05-20	李国常

4

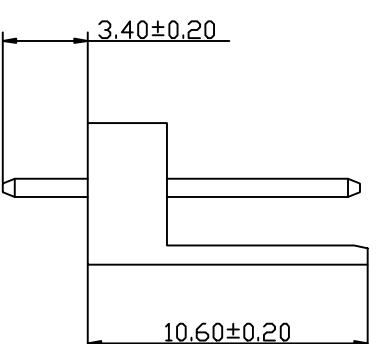
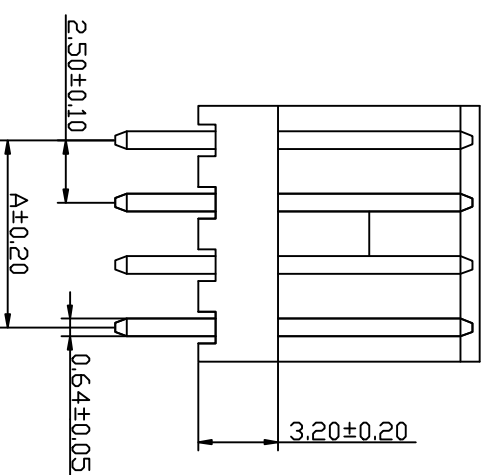
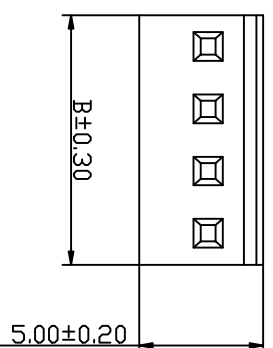

Part No	Dimensions (mm)	
	A	B
W2540V-02	2.50	5.00
W2540V-03	5.00	7.50
W2540V-04	7.50	10.00
W2540V-05	10.00	12.50
W2540V-06	12.50	15.00
W2540V-07	15.00	17.50
W2540V-08	17.50	20.00
W2540V-09	20.00	22.50
W2540V-10	22.50	25.00
W2540V-11	25.00	27.50
W2540V-12	27.50	30.00

- SPECIFICATIONS**
- Voltage rating: 250V AC, DC
 - Current rating: 3A, AC, DC
 - Withstanding Voltage: 1500V AC/minute
 - Insulation resistance: 1000MΩ min
 - Temperature range: -40℃~+85℃
 - Contact resistance: 20MΩ max
- WAFER**
- Part No: W2540V-NP
 - Poles: 02-12
 - Material: Nylon 66 UL94V-2
 - Pin Material: Brass /Tin-plated

4

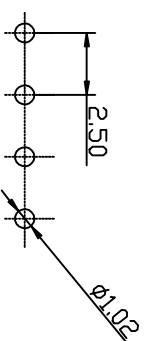

P.C.B LAYOUT

KLIT 深圳市康利通电子科技有限公司

TOCERANCE

0±0.30

.0±0.25

.00±0.20

.000±0.015

VER No SIZE

A A4

TITLE	成品规格图		TOCERANCE	
CHECKED BY	DATE	SCALE	VER No	SIZE
DRAWN BY	UNIT:mm		A	A4
李国常	2016-05-20	1:1		
PART NO	W2540V-NP			

B

C

D

E

F

1

B

C

E

公差表

REV	ECN NO	LOCATIONS	DESCRIPTION	DATE	CHANGER
A			新版本	2016-05-20	李国常

4

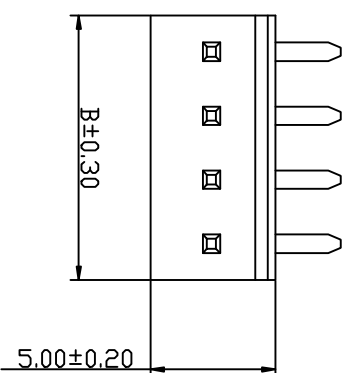

4

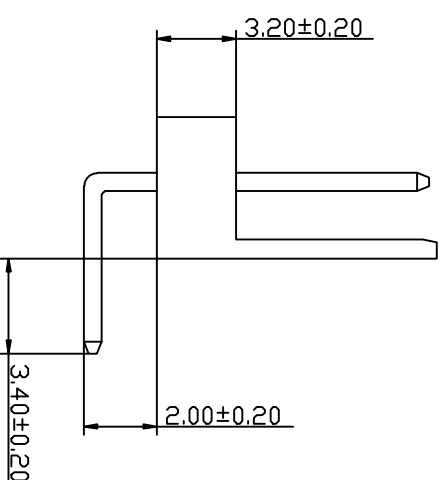
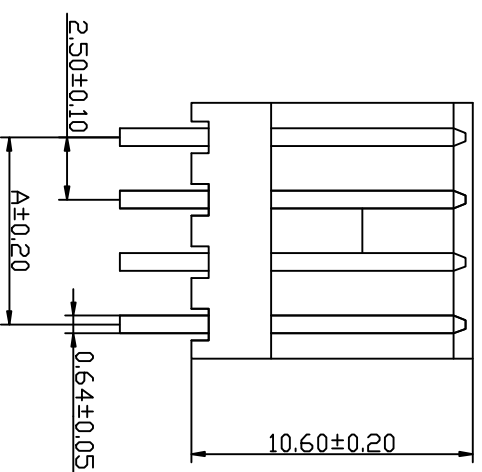

Part No	Dimensions (mm)	
	A	B
W2540R-02	2.50	5.00
W2540R-03	5.00	7.50
W2540R-04	7.50	10.00
W2540R-05	10.00	12.50
W2540R-06	12.50	15.00
W2540R-07	15.00	17.50
W2540R-08	17.50	20.00
W2540R-09	20.00	22.50
W2540R-10	22.50	25.00
W2540R-11	25.00	27.50
W2540R-12	27.50	30.00

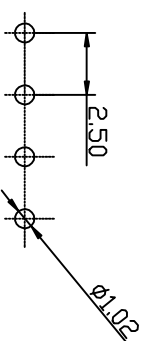

P.C.B LAYOUT

B

C

D

E

F

 深圳市康利通电子科技有限公司		TOLERANCE	
		0±0.30	
TITLE	成品规格图	0±0.25	
CHECKED BY	DATE	.00±0.20	
	2016-05-20	.000±0.015	
DRAWN BY	UNIT:mm	SCALE	VER No
李国常		1:1	A
PART No			SIZE
			A4
			W2540R-NP

1

B

C

E

公差表

REV	ECN NO	LOCATIONS	DESCRIPTION	DATE	CHANGER
A			新版本	2016-05-20	李国常

■ SPECIFICATIONS

- Voltage rating: 250V AC, DC
- Current rating: 3A, AC, DC
- Withstanding Voltage: 1500V AC/minute
- Insulation resistance: 1000MΩ min
- Temperature range: -40℃~+85℃
- Contact resistance: 20MΩ max

4

4



深圳市康利通电子科技有限公司

TOLERANCE

0±0.30

.0±0.25

.00±0.20

.000±0.015

VER NO SIZE

A A4

1

TITLE

成品规格图

CHECKED BY

DATE

SCALE

2016-05-20

1:1

DRAWN BY

UNIT:mm

李国常

PART NO

W2540RT-NP

B

C

D

E

F